

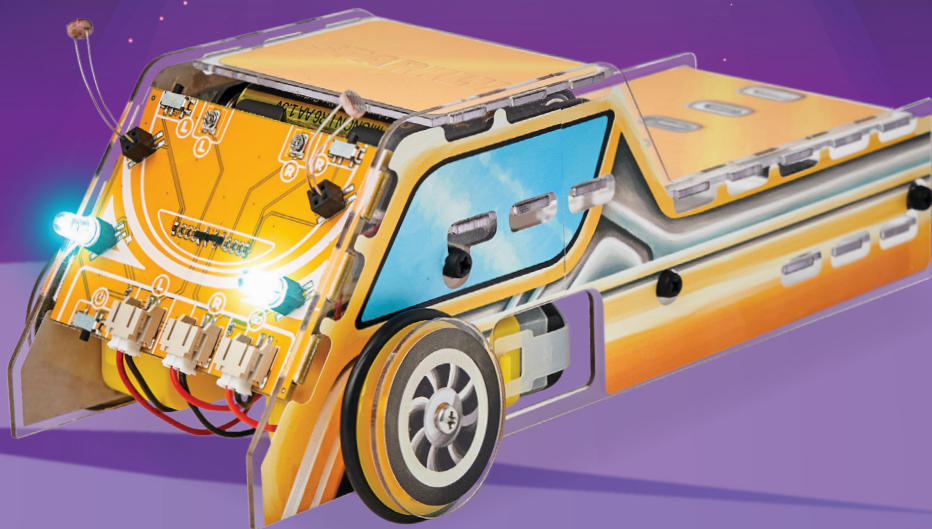

CREATOR'S BOOKLET



Enhance your STEM knowledge with the CircuitMess toy collection!

Wacky Robots are a quirky group of mini-robots that will help you master the basics of robotics and electronics.



Collect all the Wacky Robots and unlock new games for the BIT!

Insert the Wacky
Robots into the BIT
game console.

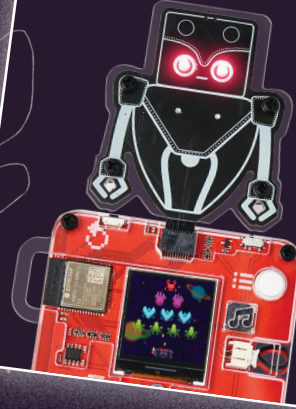

Connect your robots to Sparkly, a robot
car that follows the source of light.

Sparkly, BIT, and Wacky Robots are sold separately.

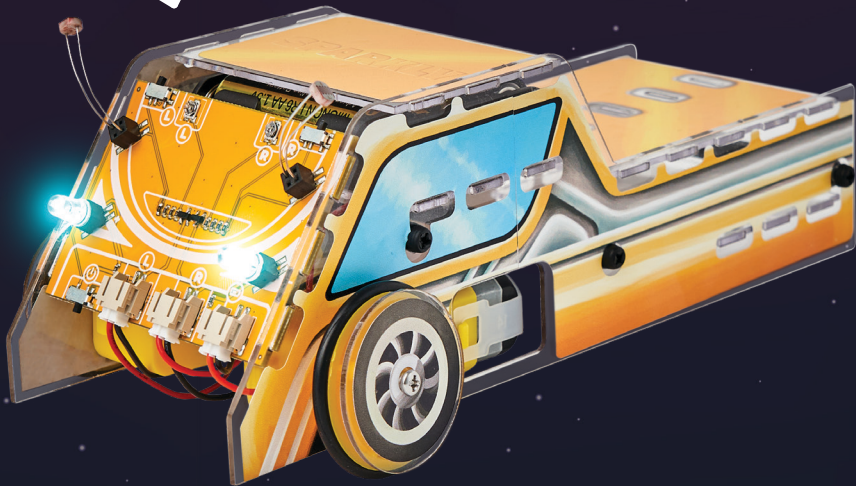

Meet CircuitMess Sparkly

Introducing Sparkly, your new robot car that will introduce you to the exciting world of robotics and STEM.

Sparkly teaches you about different electronic components and how photoresistors work. Finally, you'll have a cool car for transporting your Wacky Robots!



How does it work?



Assemble your robot car



Learn **STEM** while playing



Connect Sparkly with Wacky Robots



✦ What is CircuitMess?

CircuitMess started in 2016 when Albert (our CEO) was 17.

Albert loved tinkering with electronics, and one of his first projects was a DIY game console.

People liked the idea, so he launched it on **Kickstarter**, which raised \$100,745!

After that, CircuitMess was born. We are a small and fast-growing team of tech lovers who wish to share our love of creating new technology with the rest of the world!

Albert



All of our kits are developed, manufactured, and packed in Croatia!

✦ Behind the name

Circuit Mess

electronic
circuits

creative mess in
our heads



✦ The mission

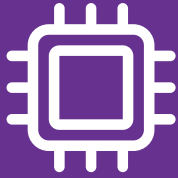

Everybody knows how important technology is, but less than 1% of the population knows **HOW TO MAKE** new technology.



















We're here to change that! With our kits, we want to inspire people to be **CREATORS** instead of just consumers.





What's inside the box?

- | | | | | | |
|----------|---|------------------|-----------|---|-------------------------|
| 1 |  | Stickers | 9 |  | Photoresistors |
| 2 |  | Acrylic casings | 10 |  | Small metal screws |
| 3 |  | AA batteries | 11 |  | Large plastic bolts |
| 4 |  | Battery holder | 12 |  | Electromotors |
| 5 |  | LEDs | 13 |  | Metal ball caster wheel |
| 6 |  | PCB | 14 |  | Small plastic standoffs |
| 7 |  | Large standoffs | 15 |  | Small plastic bolts |
| 8 |  | Big metal screws | 16 |  | Wheels |

You'll learn about:



Electronics and different electronic components



Photoresistors



Photoresistance

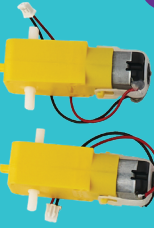
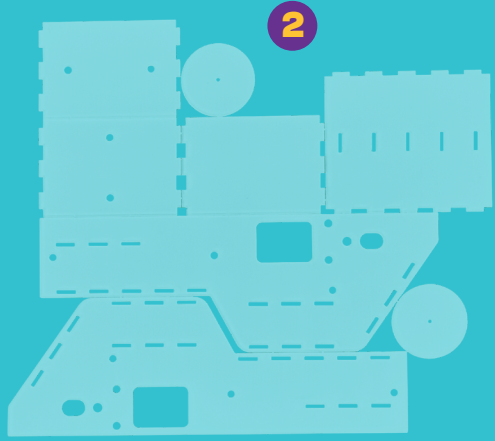

✦ **Lighting the way:** **How photoresistors enable your Sparkly to move**

Sparkly has photoresistors that help it move towards the light.

Photoresistors are electronic components that change resistance when exposed to light.

**When light falls on
the photoresistor, its
resistance decreases,
allowing current to flow.**

Sparkly has two photoresistors that help it detect the source of light and adjust its movements accordingly.



✦ Photoresistors



The photoresistor was invented by American engineer and inventor **Joseph John Lister**, and the product was patented in **1930**.

The first photoresistor was used on a vacuum tube to measure the strength of radio signals shown on a fluorescent screen. The idea was to help users improve their radio reception.



Photoresistors

✦ Potentiometer

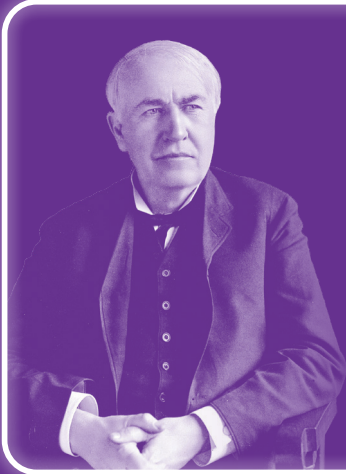

In **1872**, **Thomas Edison** invented the first potentiometer.

A **potentiometer** is a manually adjustable resistor with 3 terminals. Two terminals are connected to opposite ends of the resistive element, while the third is connected to a sliding contact called the wiper, which slides across the resistive element.

The **resistive element** is a series of two resistors, where the position of the wiper determines the ratio of the resistance of the first resistor to the second resistor.

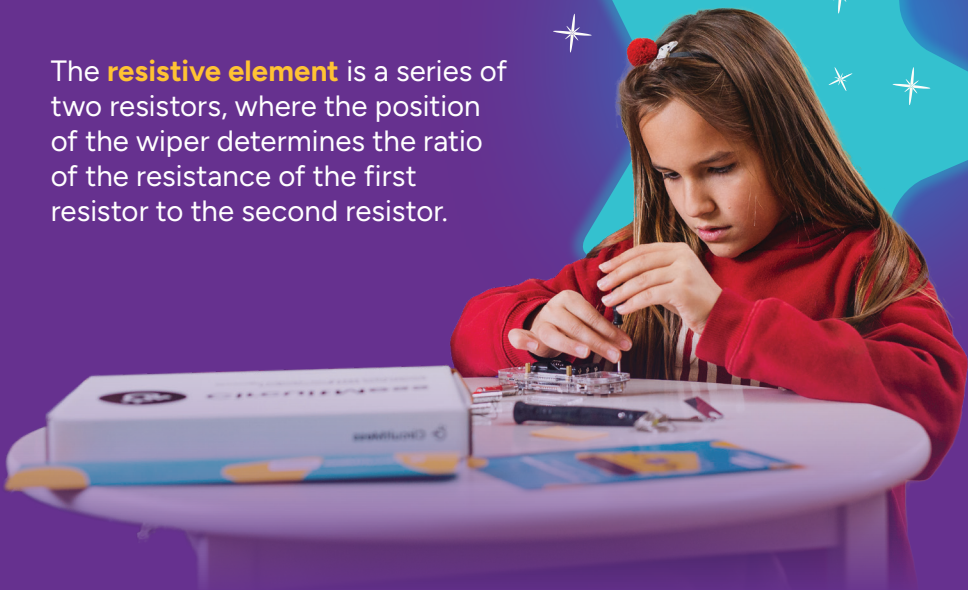

Potentiometers take an input voltage and transmit varying amounts into an electrical circuit. The position of the wiper determines this amount.

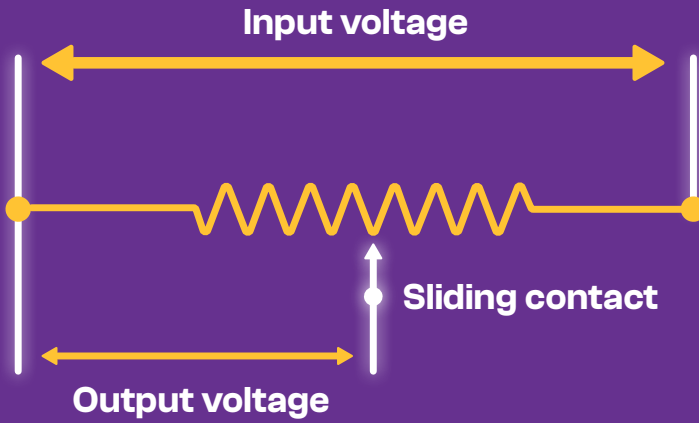

Different types of potentiometers:

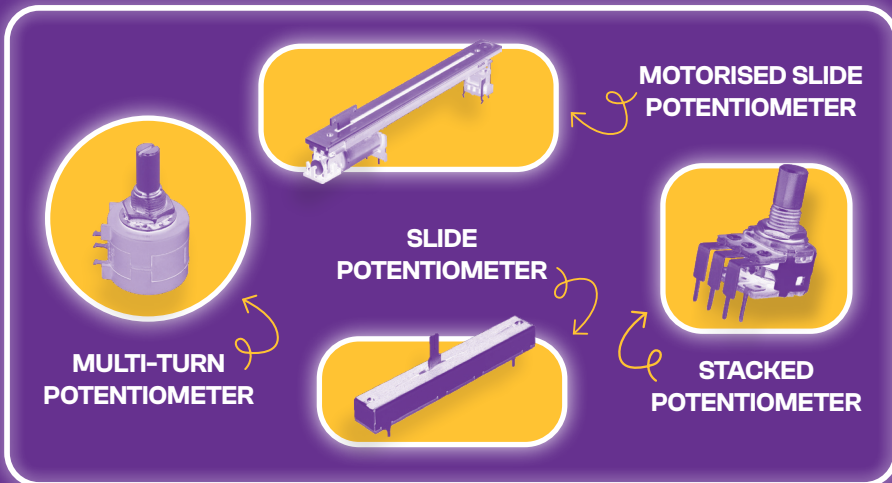



Safety first

Before you start with the assembly, pay attention to the following safety measures:



Handling a screwdriver is not recommended for children under the age of 7!



Keep CircuitMess Sparkly away from young children! This product contains small components that are dangerous to children under the age of 3.



If you are a minor, assemble Sparkly strictly with the help of an adult.

Closely follow all the instructions you received in this kit and those found on our online pages so that no one gets hurt.

If you have never used a screwdriver, carefully follow the assembly instructions on our website and, if necessary, ask someone more experienced or older than you to help you.

If you are having problems with our kit, contact our customer support via email at contact@circuitmess.com.

✦ Sparkly Build Guide

1 ACRYLIC CASINGS

You'll need to break one large acrylic piece from the kit to get a bunch of smaller casings.

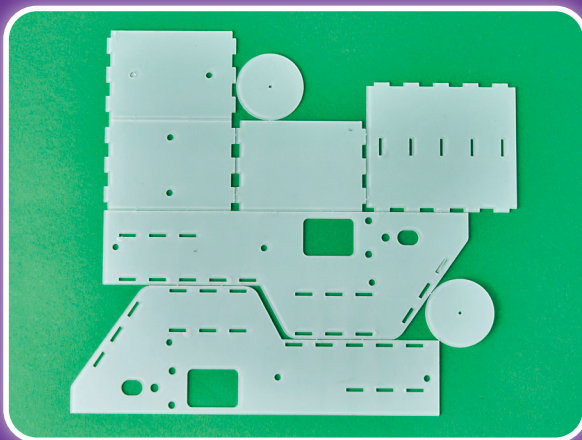

Warning: Be careful when breaking to avoid damaging the parts you need.

In the end, you should have **eight separate pieces of acrylic casings**.

If you have excessive acrylic in the holes on the casings, simply push it out.

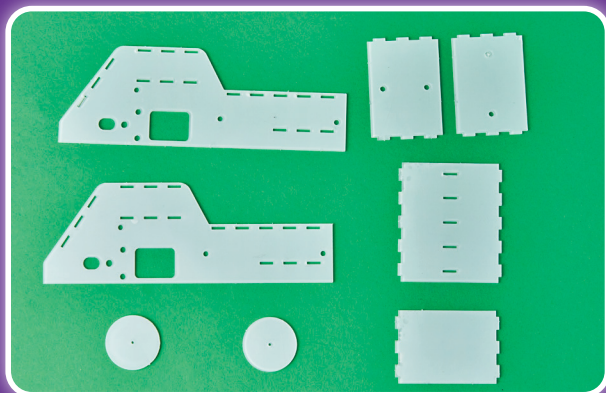

This is what your casings should look like



Remove the protective foil from both sides of the casings now:



After removing the foil, the casings should be transparent.

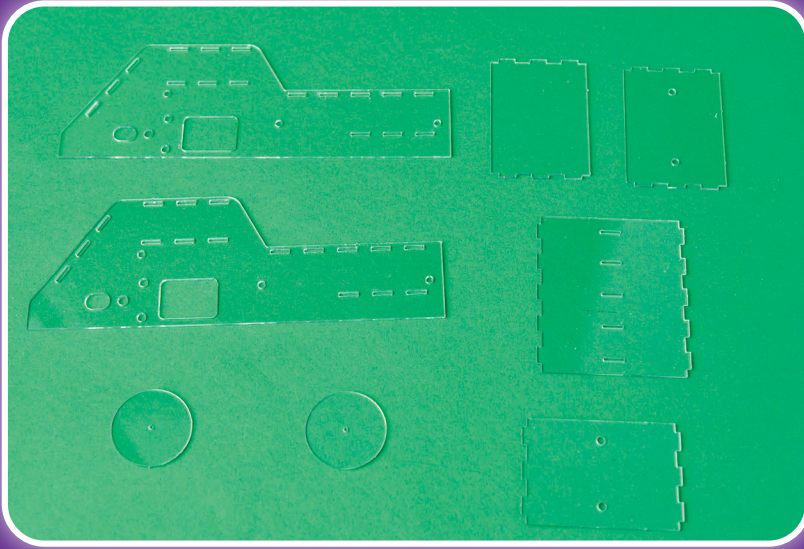

Now it's time for Sparkly to get a fun look!
Grab the stickers, and let's begin.

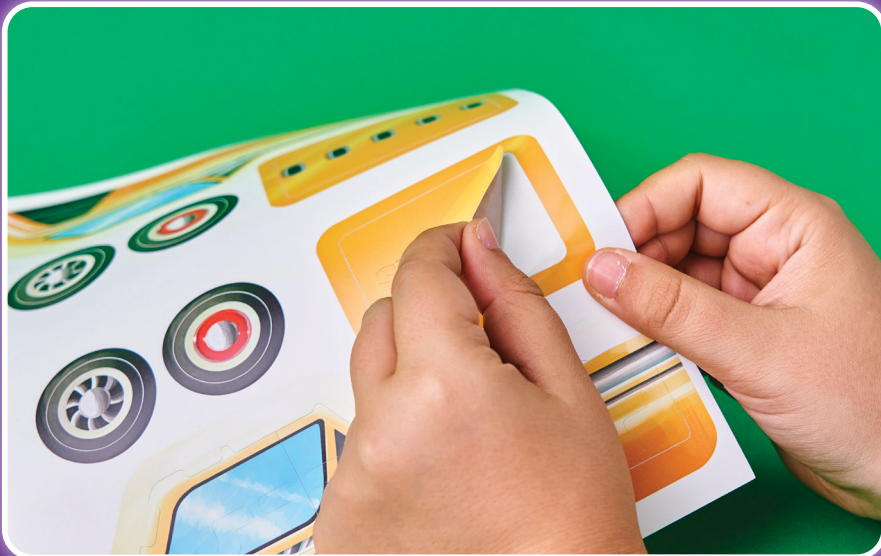



Check that each part is stuck to the correct side.
Your acrylic casings should look like this in the end:

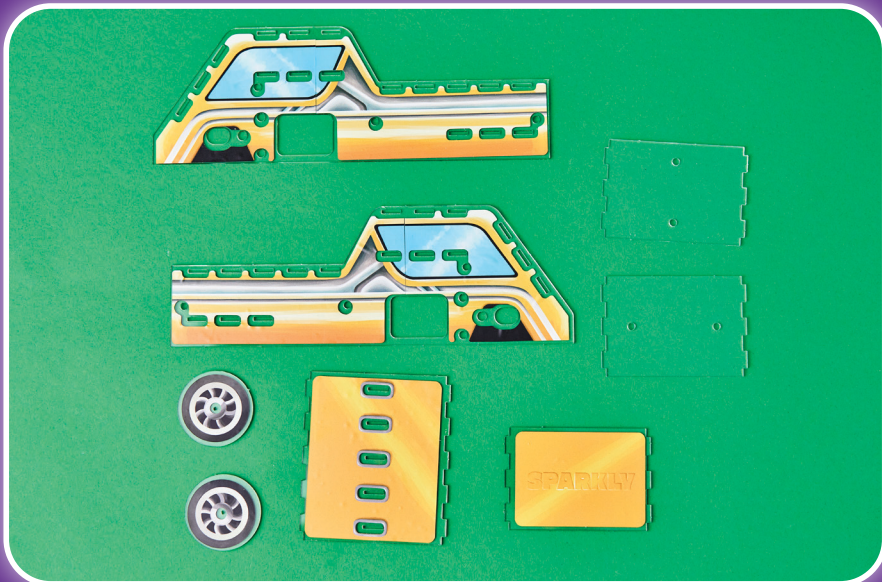

**We've prepared two designs for the
wheels for you to select from.**

2 ASSEMBLY

We may now begin the assembly.
Firstly, take the PCB and both electromotors.

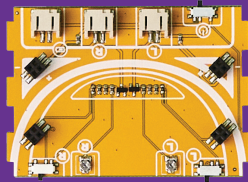

PCB

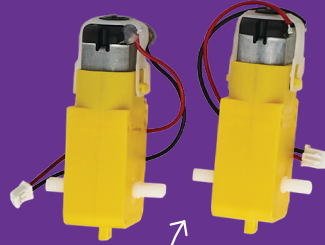

Electromotors

Markings (the letters L and R) indicate **where the electromotors must be connected**.
Connect the motors like this:

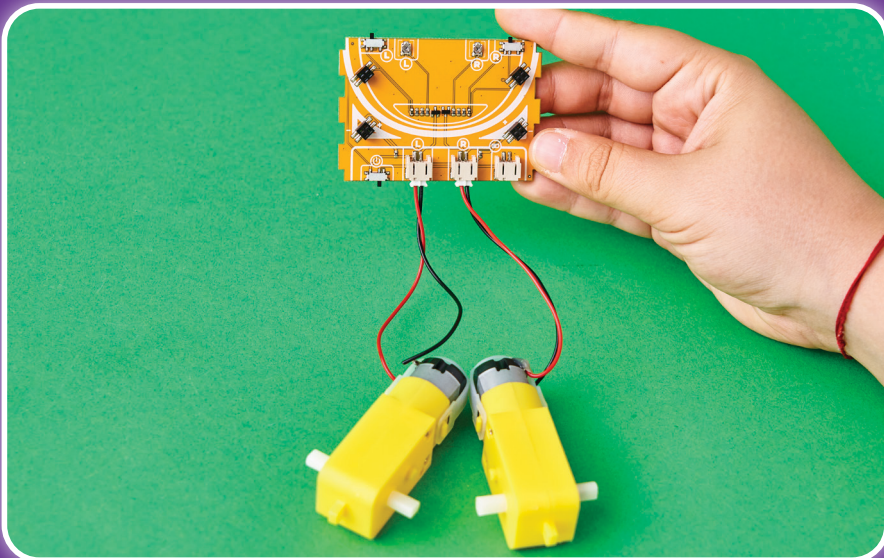

Turn the board around, cross the motor wires, and rotate the motors in the opposite direction of the board. This part will be important for later assembly.

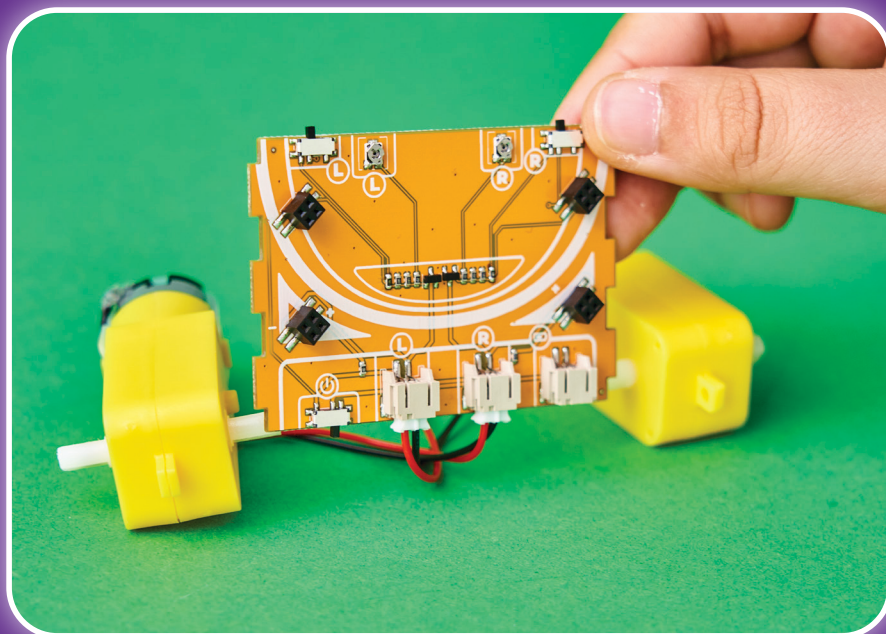
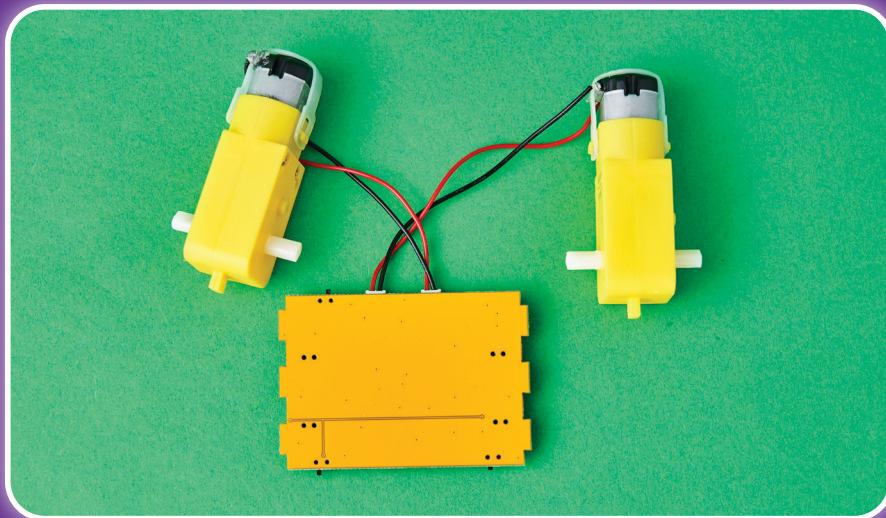

The next step is to connect the batteries to the board and **test whether the motors are moving in the right direction.**

We'll need a **battery holder**, two small metal screws, two small plastic standoffs, and three AA batteries for this.

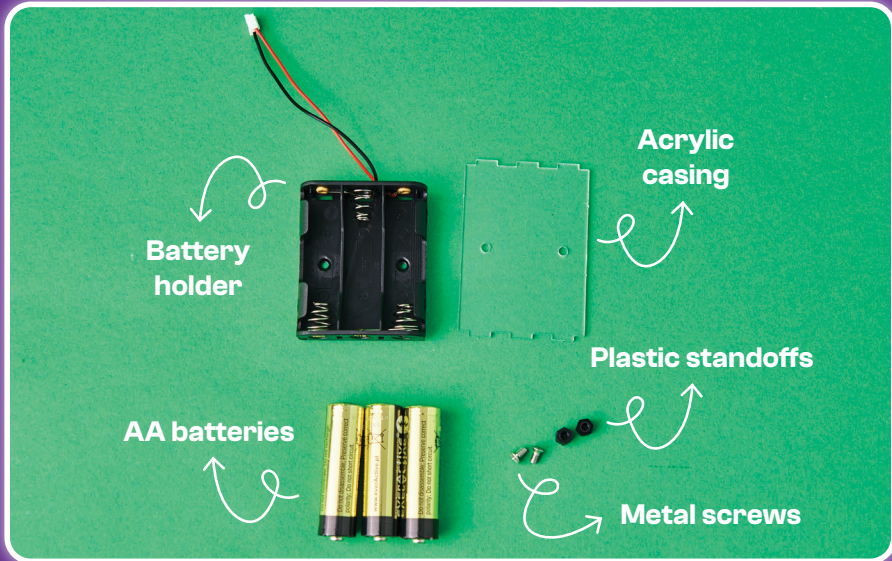

To begin, **insert the metal screws** into the battery holder.

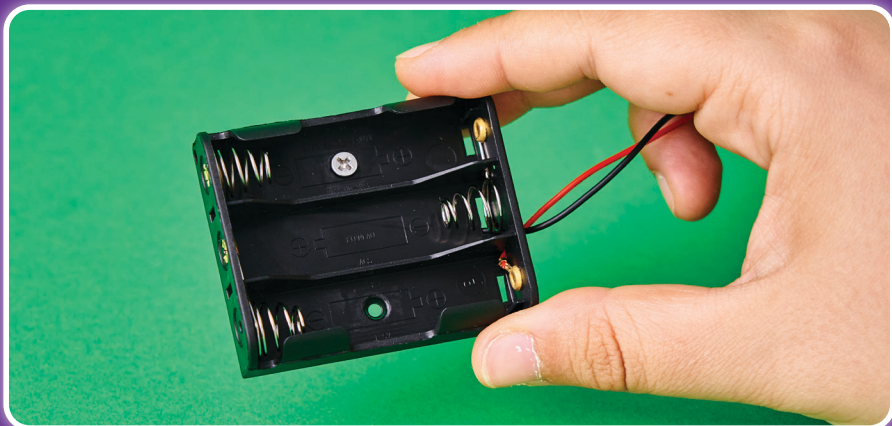

We will attach the acrylic casing from the photo below to the back side of the holder so that the holes on the casing match the holes on the holder.

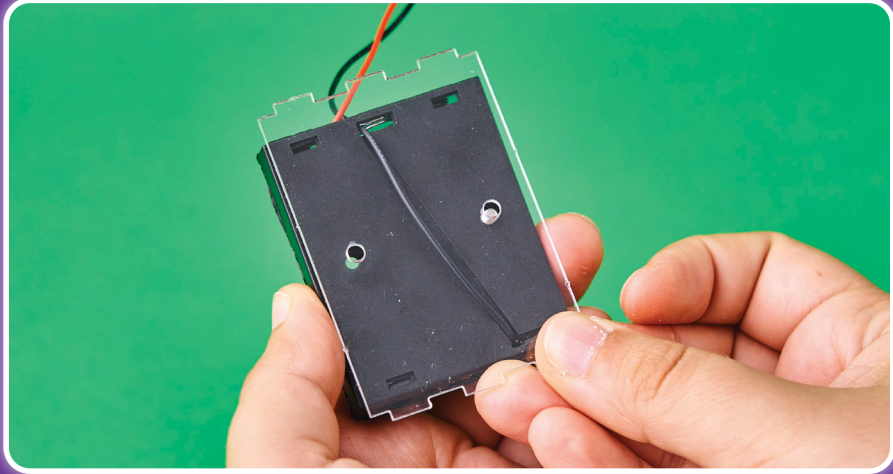

Take the standoffs and fasten the holder and casing using them.

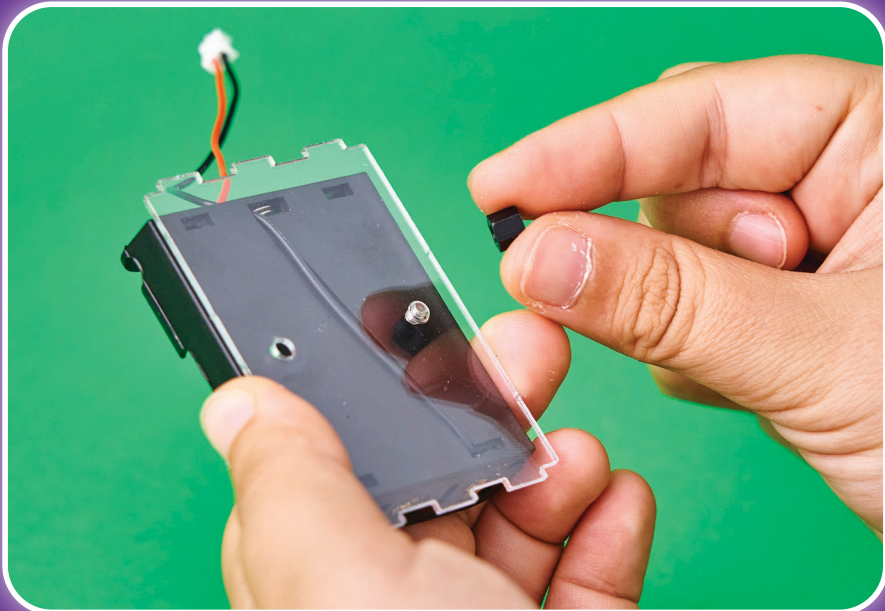

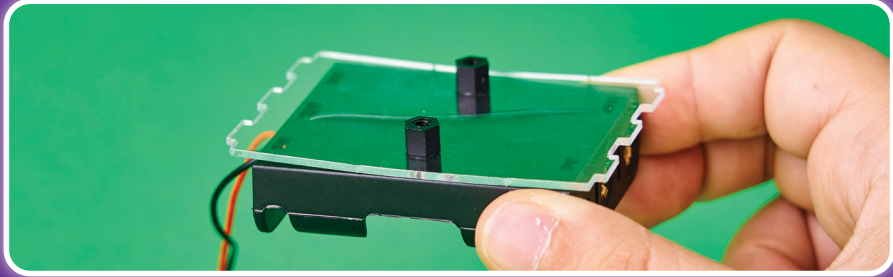

It's time to put the batteries in.

During this step, pay attention to the **battery polarity (+ and -)**. Both on the battery and on the holder, it's indicated which way the batteries should be positioned.

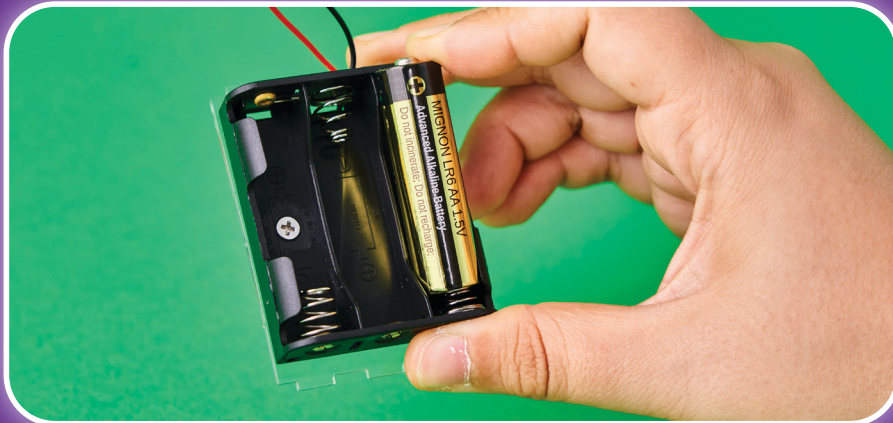

Plug in the connector from the holder into the PCB. The slot is located next to the motors and marked with a battery icon.

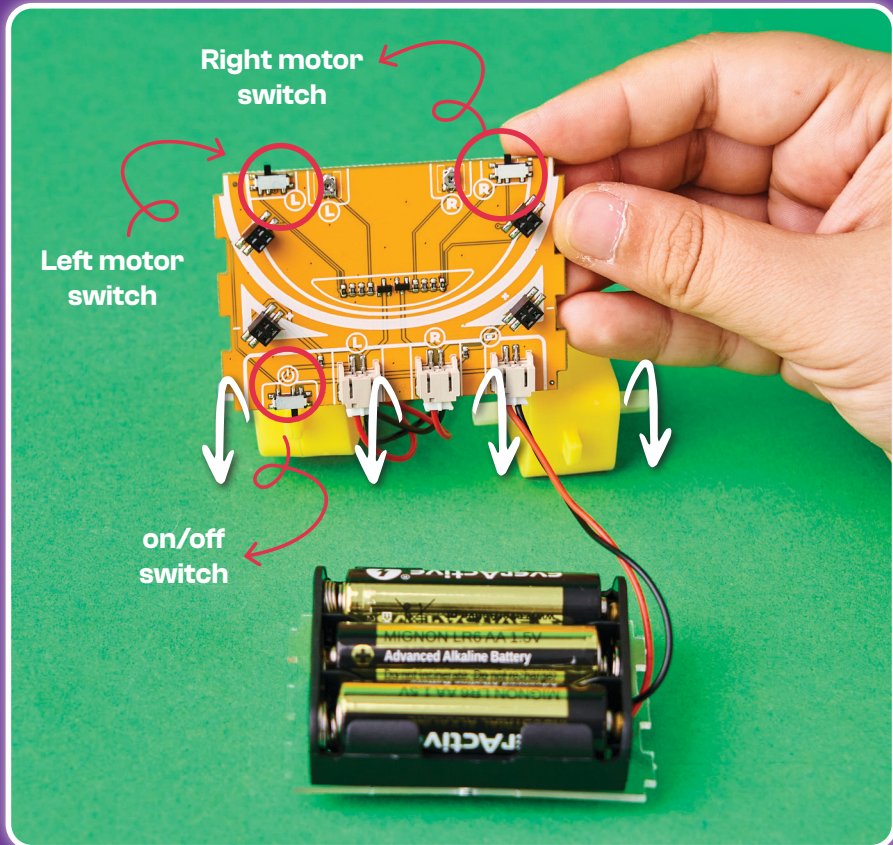

Turn on both motors by using the switches labeled L and R.

If they are correctly positioned, both motors should rotate in the same direction.

If they don't rotate in the same direction, flip them over and check if they are now rotating correctly.

For the next step, we will need the following components:

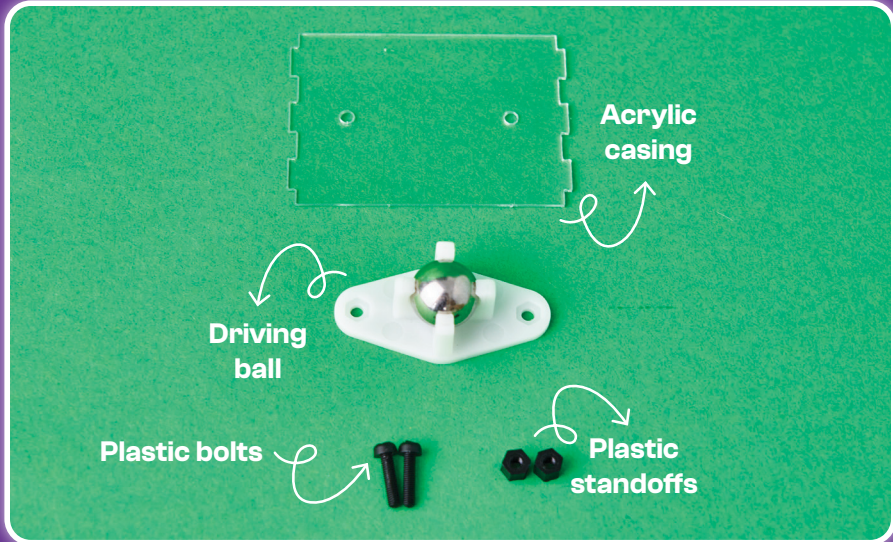

Put the casing on the bottom of the ball and put the bolts through the plastic part of the ball and the casing.

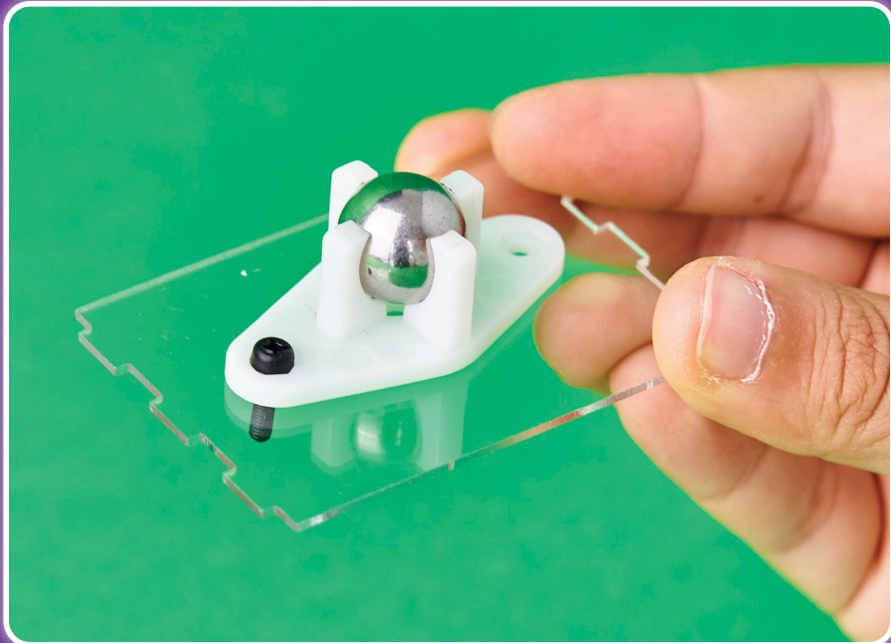

We'll use the standoffs to fasten it on the backside.

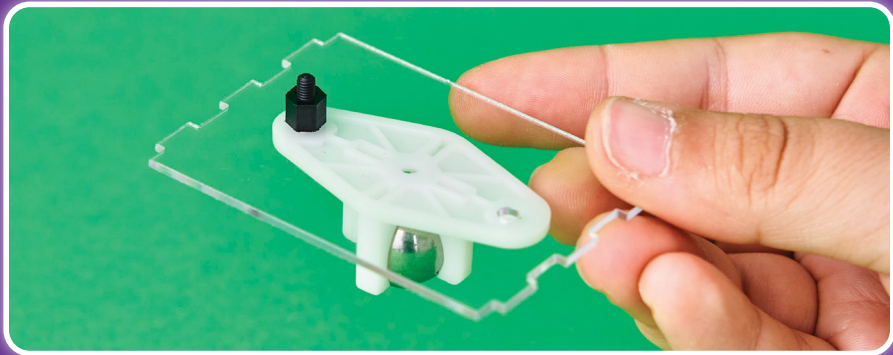

Repeat the step for the remaining bolt and standoff.

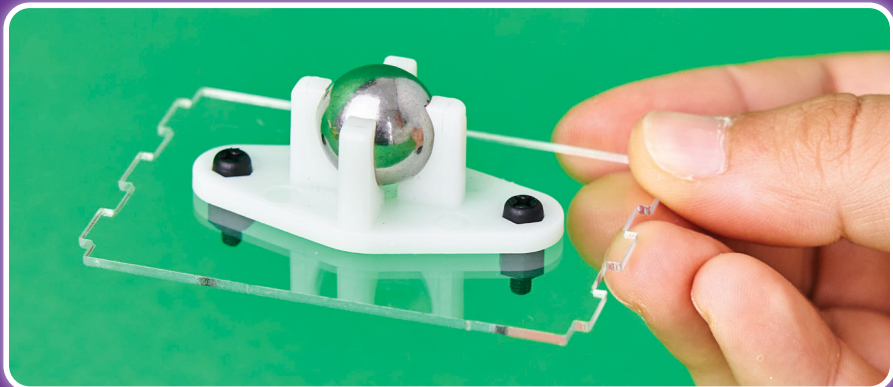

Set this aside and take the following components:

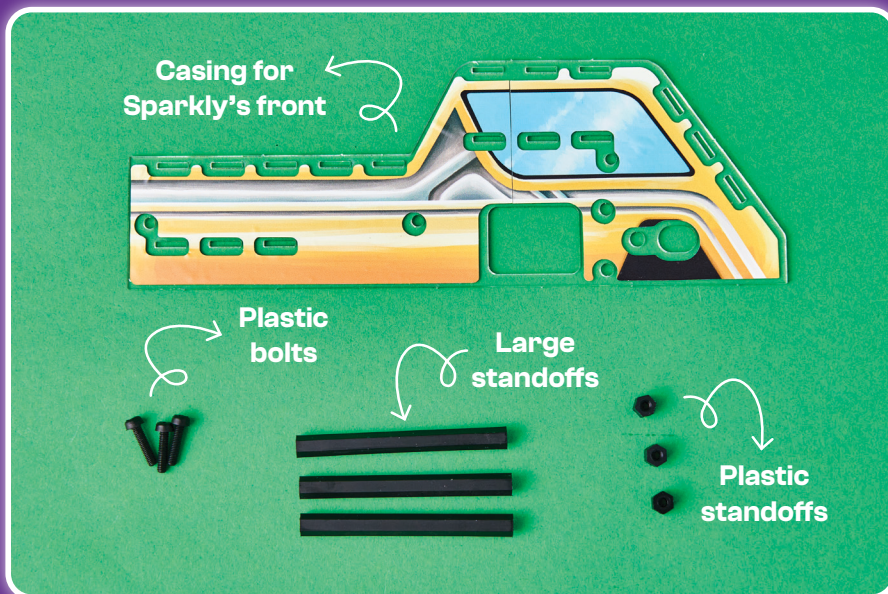

Place one of the bolts here:

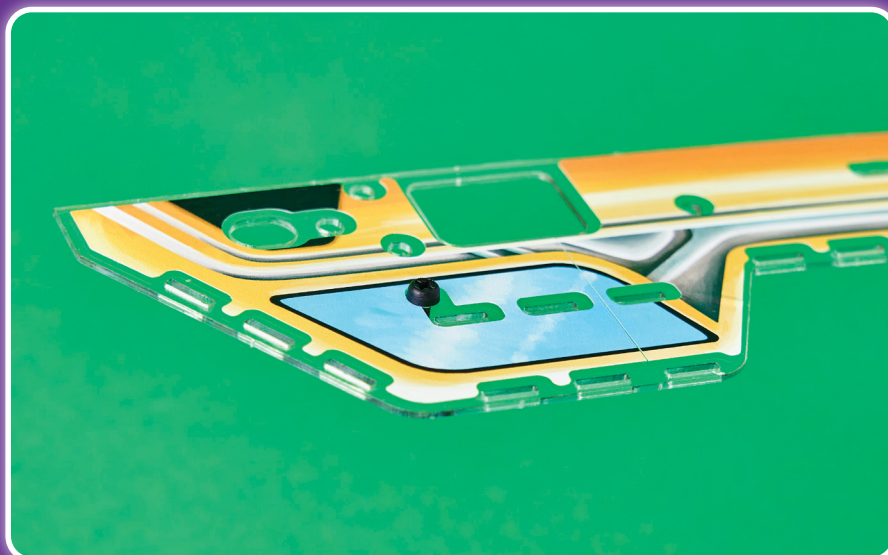

Fasten it with the smaller standoff from the inside.

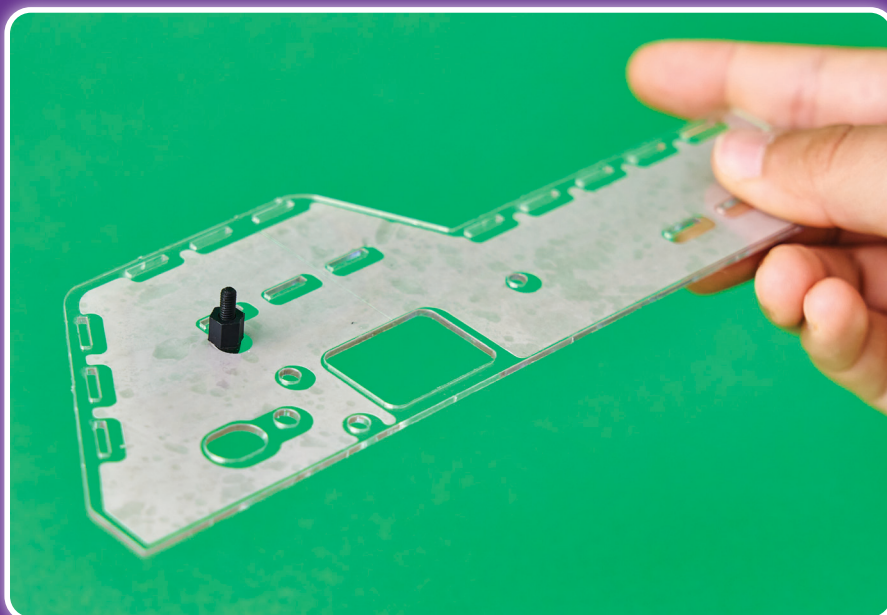

Then, add the large standoff on top of it.

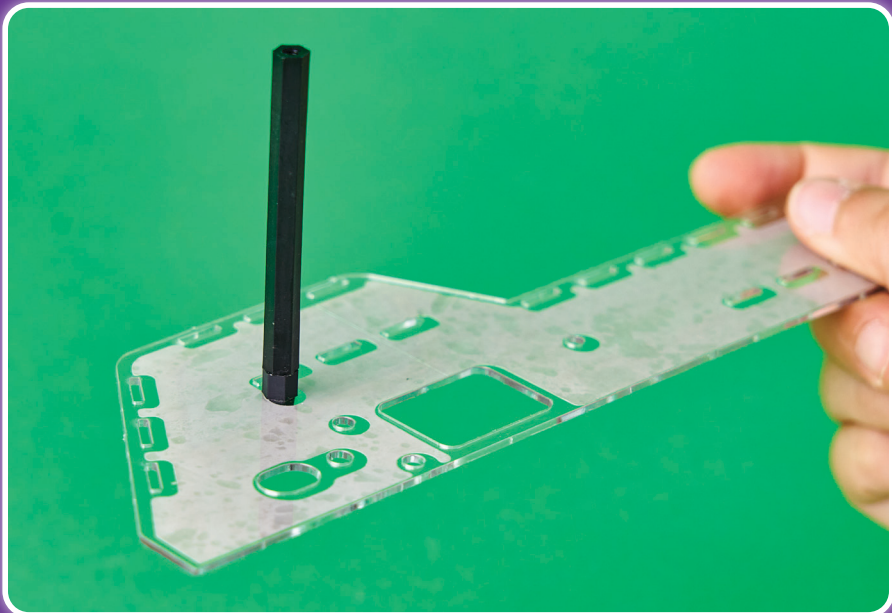

Repeat the step two more times as shown in the photo:

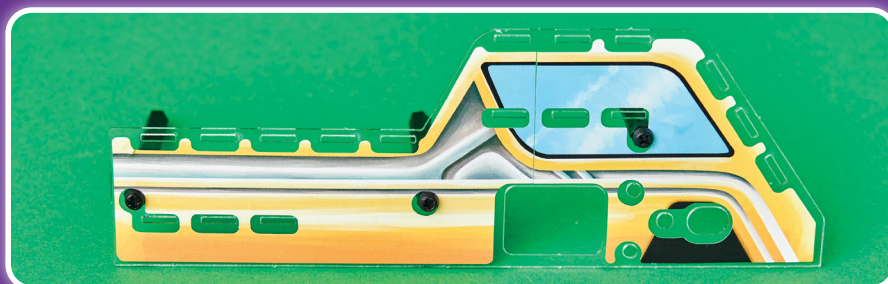

Take the part with the PCB and electromotors and connect one of the motors to the casing like this. Be careful not to change the motor's position.

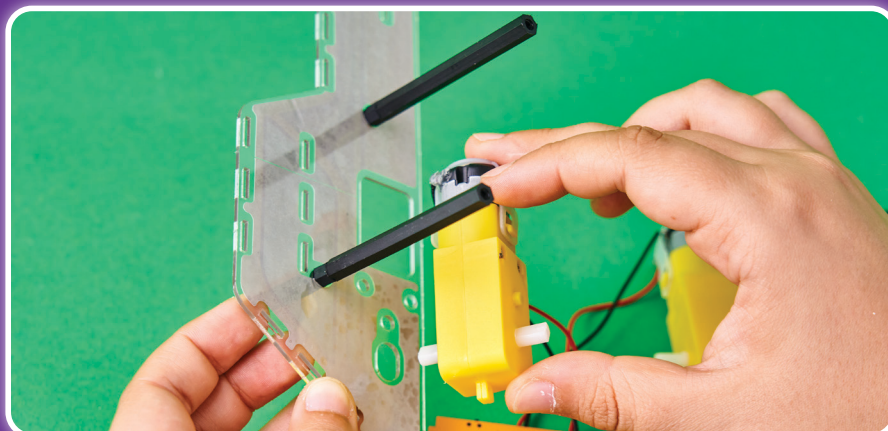

Put one of the large plastic bolts through the casing and one of the holes in the motor.

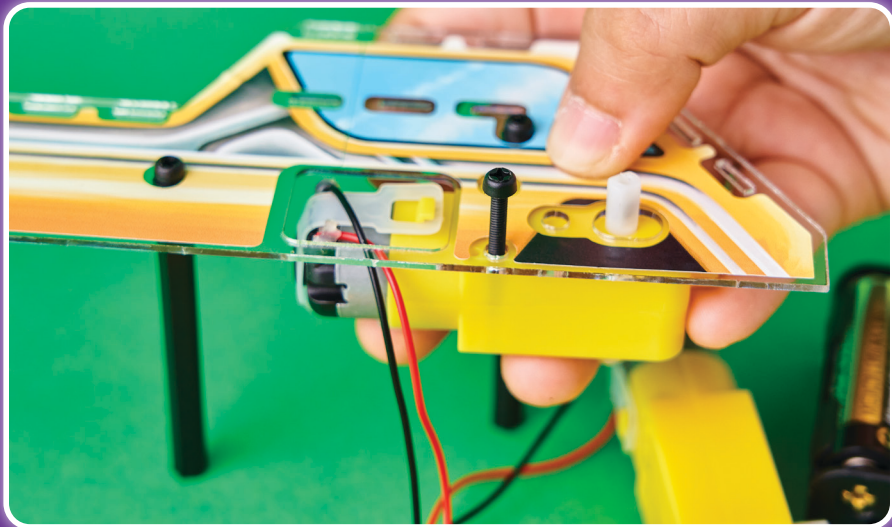

You'll fasten the bolt with the standoff.



Then, repeat the step with another large bolt and standoff. This is what the motor should look like:

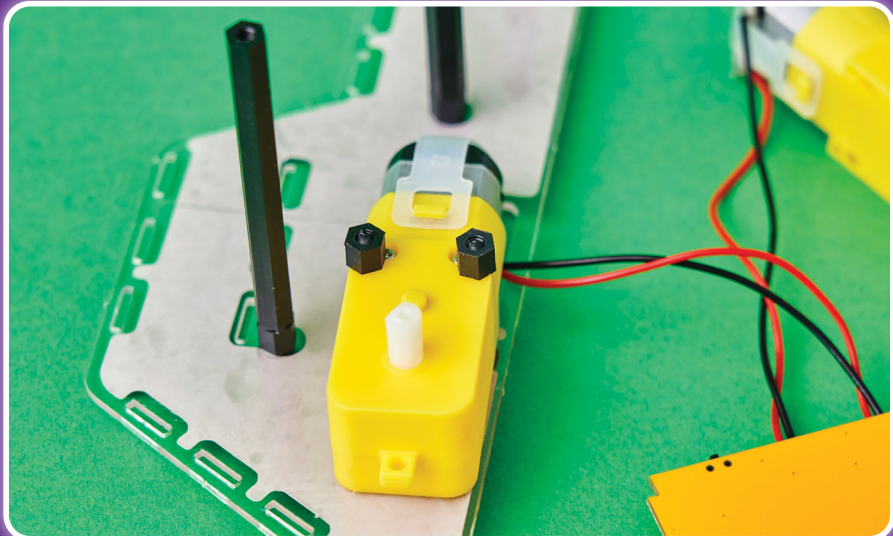

Connect the PCB and the casing like this:

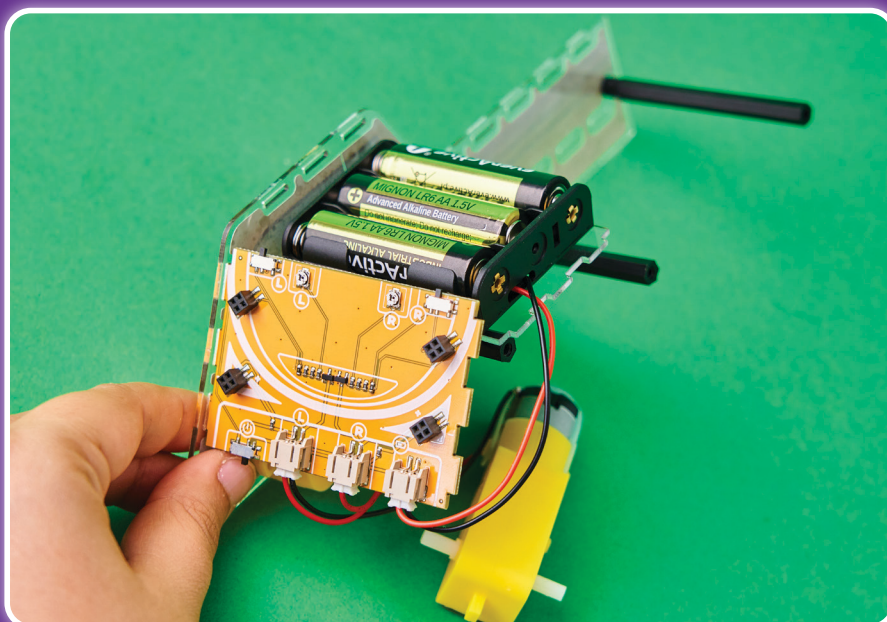
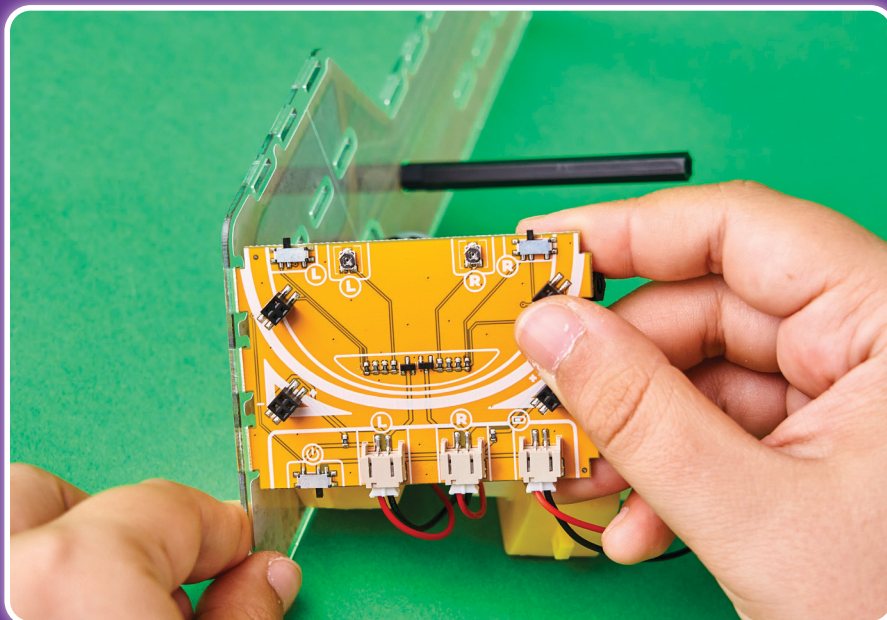

Connect the motor to the second acrylic casing that represents one side of the car in the same way. Sparkly should now look like this:

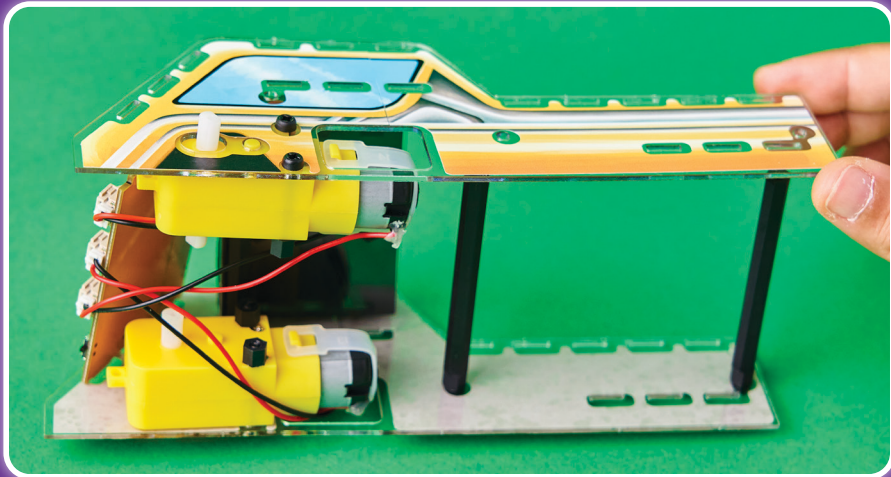

On the bottom, add the part with the ball.
Make sure the ball is facing the floor.

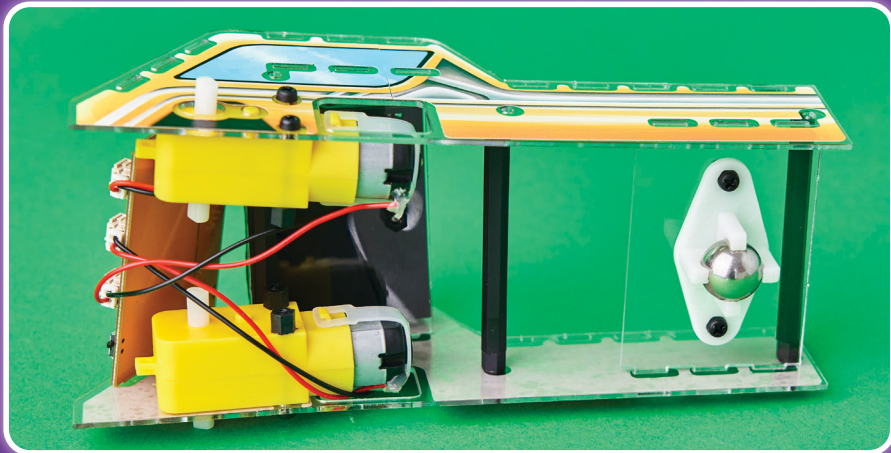

Take **three plastic bolts** to connect these two casings.



We'll need a screwdriver for this step.

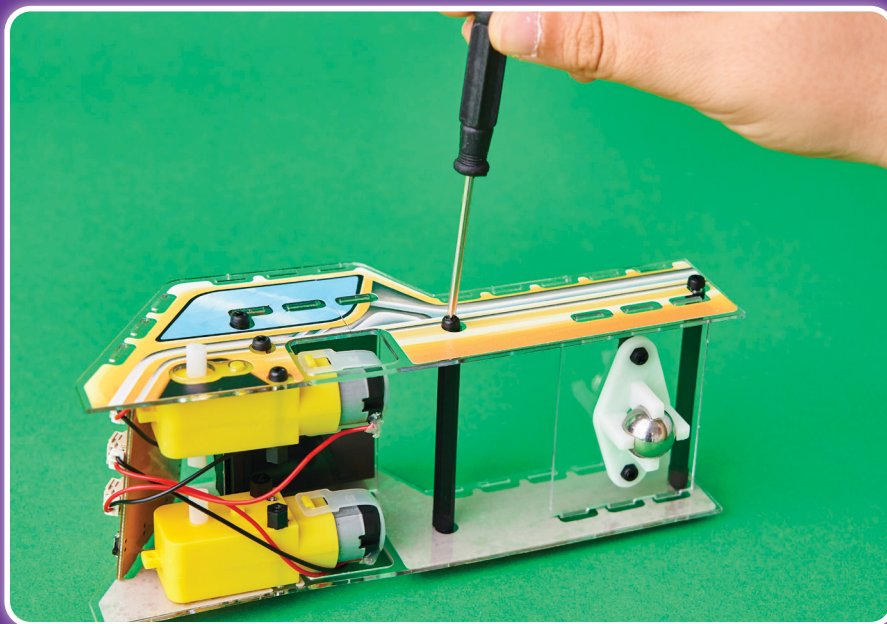

We can proceed if everything is connected.

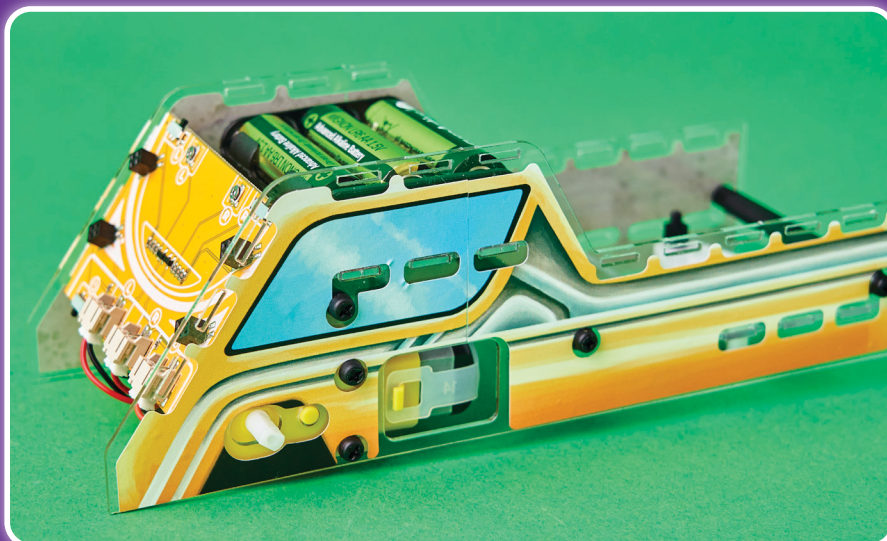

We need to add wheels to Sparkly in order for him to move. Take the assembled part, wheels, two circle-shaped casings and two large metal screws.

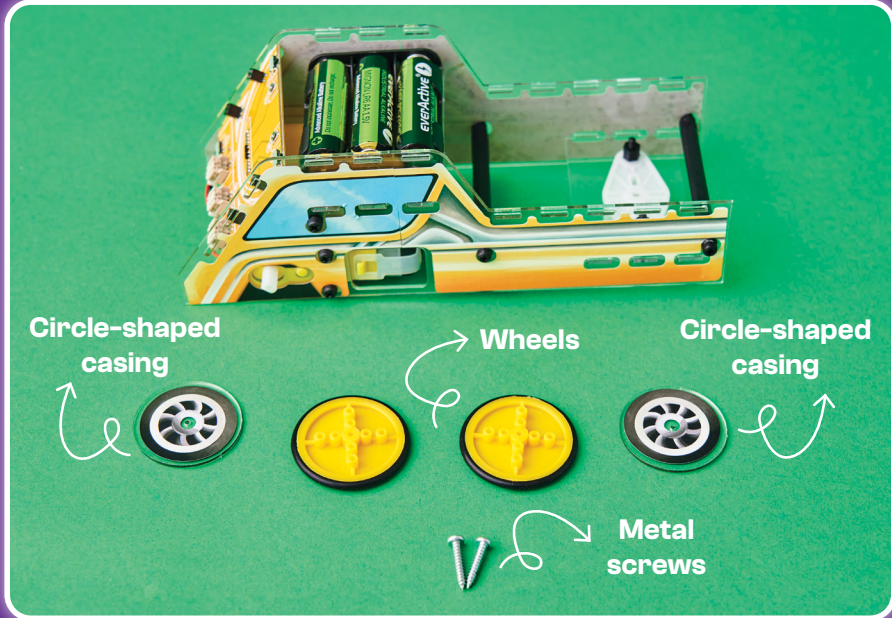

The inside of the wheels has a slot that matches the extension on the motor where it needs to be put. This is how we attach the wheel to the motor.

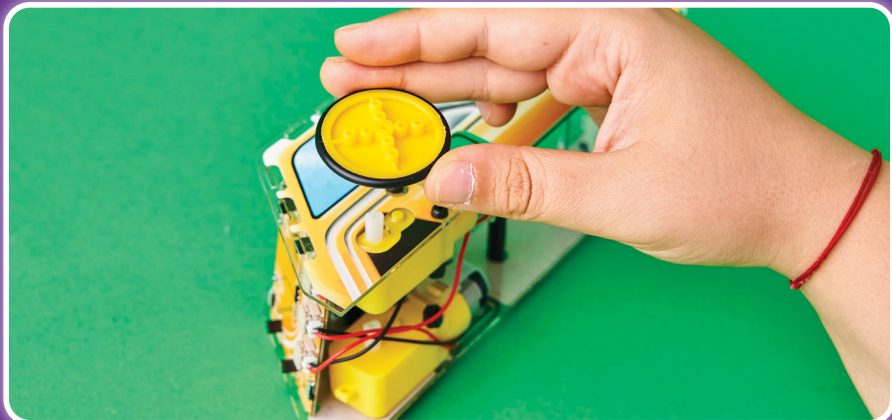

Check if the wheel is coming off from the motor.

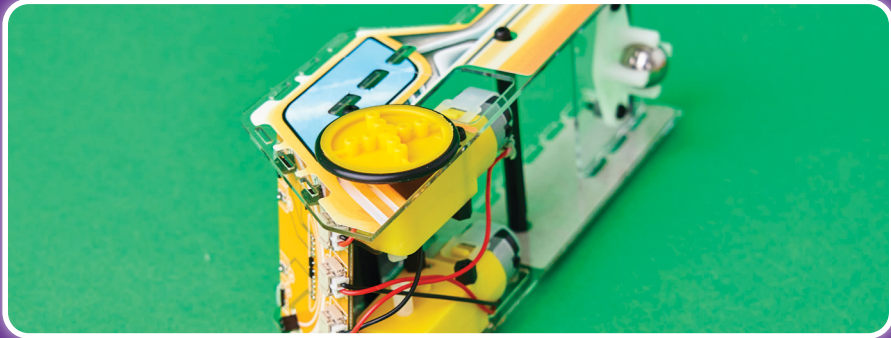

Then, take the casing and metal screw and put the metal screw through the casing and the wheel.



You'll need a screwdriver to put the screw through the casing and wheel.

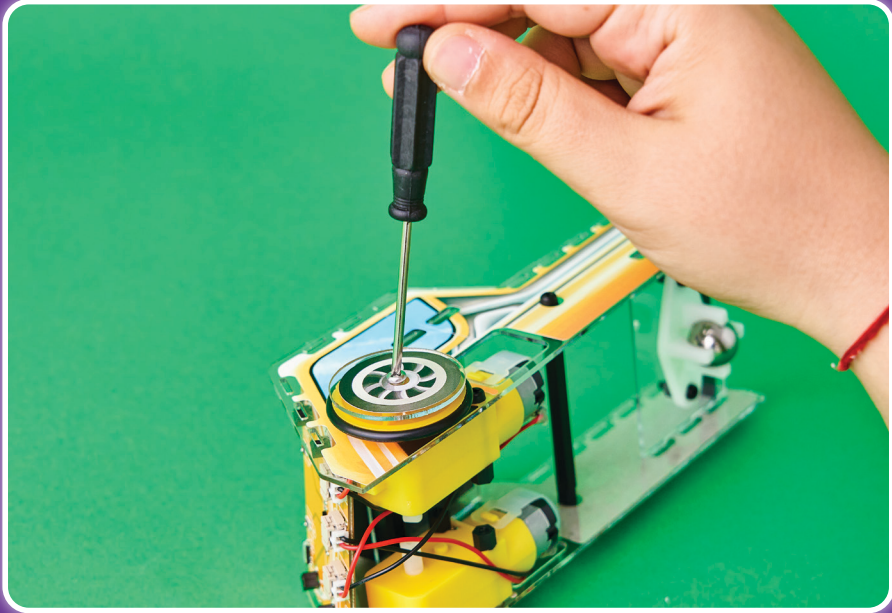

Repeat this step for the other wheel.

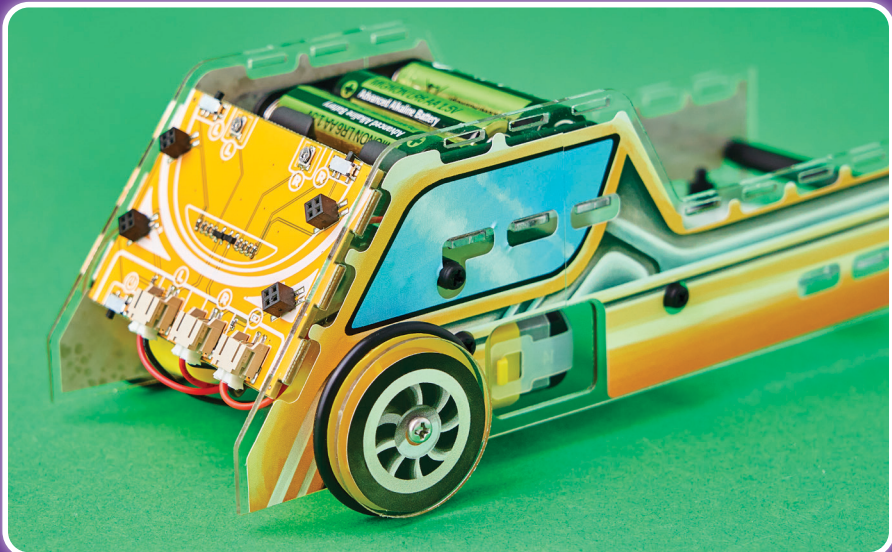

The casing with the carved slots is placed on top of your Sparkly.

You'll put your Wacky Robots in this casing
so they can drive on Sparkly.

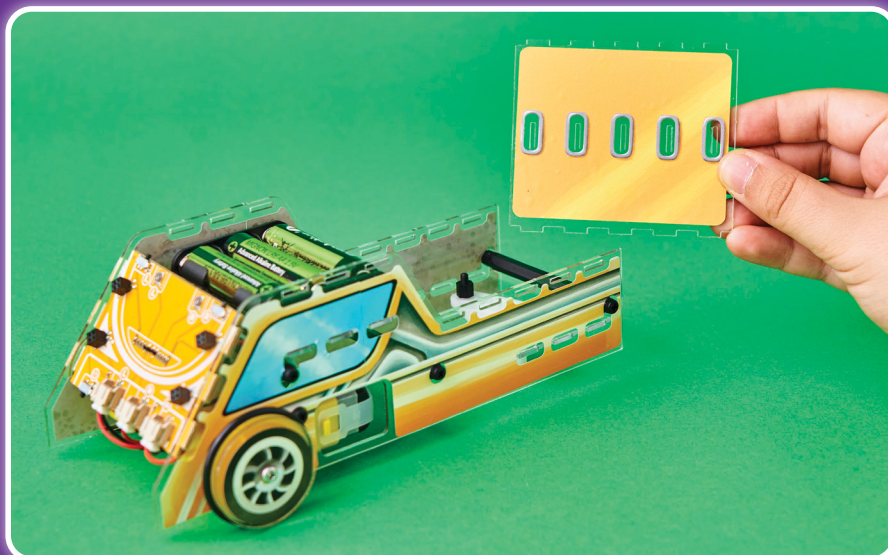

The casing with Sparkly written on it is the roof, and you have to put it here:



Take the photoresistors and the LEDs you want to put on your Sparkly.

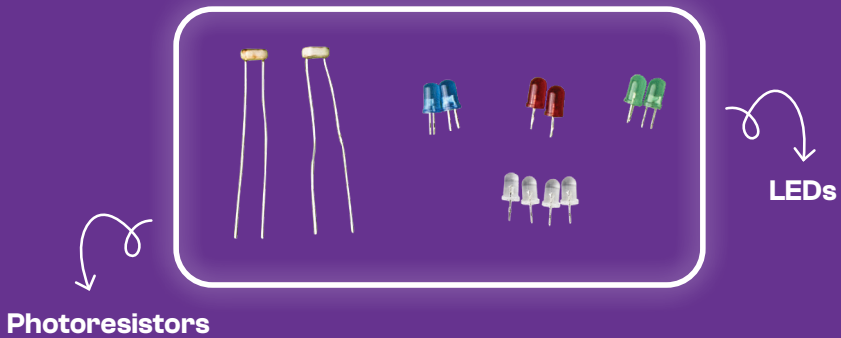

LEDs are placed into the connectors marked with + and -, while the photoresistors are placed into the connectors above them.

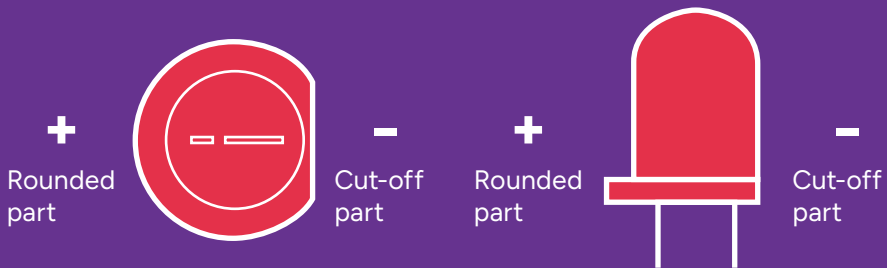
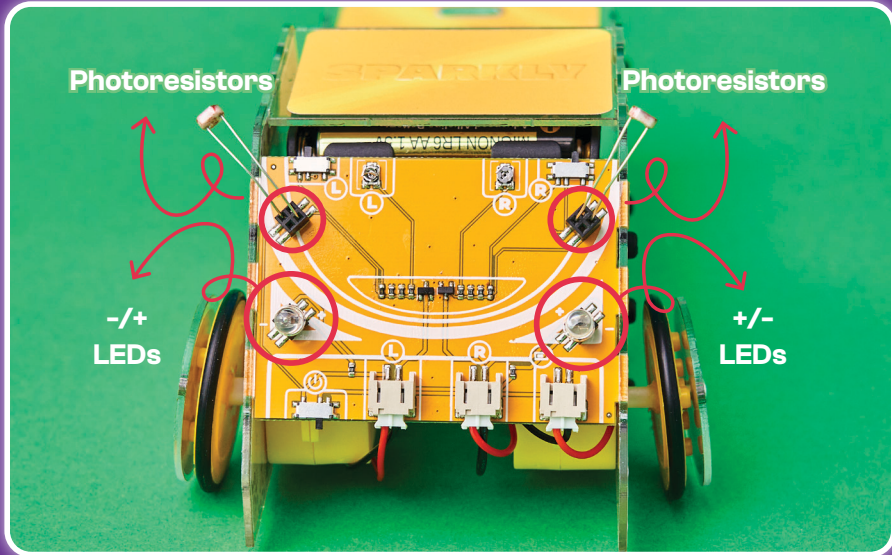

It makes no difference which way the photoresistors are oriented. They are used so that Sparky can follow the light in the dark.

When placing the LEDs, you need to pay attention to the polarity.

The plus and minus signs indicate the LED's rounded (+) and cut-off (-) parts.

Turn off the lights and bring your phone close to Sparky to see how the photoresistors work!

You'll use these potentiometers to decrease or increase the sensitivity of photoresistors in order to adjust Sparkly's sensitivity depending on the lighting in the room. You can turn the potentiometers using the screwdriver.

Potentiometers

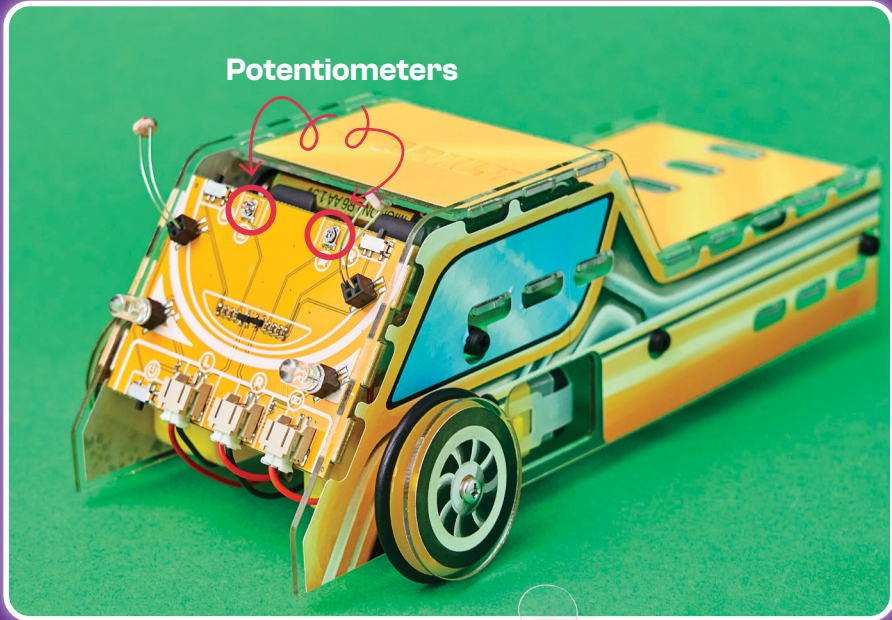

Place your Wacky Robots on Sparkly, turn it on, and watch it drive towards the light.



*Wacky Robots are sold separately

Thank you for purchasing CircuitMess Sparkly.

For more information and detailed instructions on assembling and using your device, visit our official website: circuitmess.com/resources/guides

Important safety information for CircuitMess Sparkly

Read all safety information before using the device.

WARNING: Failure to follow these safety instructions could result in fire, electric shock, injury, and damage to your device or other objects. Read all safety information before assembling and using this device.

This product is a do-it-yourself device, and for it to work properly, you must assemble it according to the instructions you'll find on our website.

If you are a minor, assemble it only under an adult's supervision to avoid potential risks.

CircuitMess Sparkly contains sensitive electronic components. CircuitMess Sparkly or its components may be damaged if dropped, burned, punctured, crushed, or in contact with liquid. If you suspect that any part of your CircuitMess Sparkly kit (especially the batteries) is damaged, stop using the device. Using a damaged device may cause injury.

Use only authorized accessories compatible with your device and/or the supplied tools.

The device's operating temperature ranges from 0 °C ~ 40 °C.

Using this device in conditions outside this temperature range may damage the device.

Please turn off CircuitMess Sparkly after use and store it in a safe and dry location.

The included battery must be recycled appropriately and/or disposed of separately from household waste.

Improper handling of batteries can cause a fire or explosion. Dispose of or recycle your device, battery, and accessories according to local regulations.

The included battery is NOT rechargeable.

- Do not short-circuit the battery
- Improper use of the battery can cause overheating, burns, or other injuries.
- Do not leave the battery directly exposed to intense sunlight.
- Do not use the device or the battery in high-temperature conditions. Overheating may cause an explosion.
- Do not disassemble or damage the battery to avoid battery leakage, overheating, or explosion.
- In the case of deformation, stop using the battery immediately and dispose of it properly.
- If you are not sure whether your device or the included battery is safe to use, turn off the device, put it in a safe place, and contact our customer support via email at contact@circuitmess.com.

Keep the device dry.

Do not attempt to repair the device by yourself.

If any part of the device does not work correctly, contact our customer support (contact@circuitmess.com) or take your device to a certified repair shop.

Connect other devices according to their operating instructions. Do not connect incompatible devices to this device.

Precautions

During prolonged use, CircuitMess Sparkly may rarely overheat.

Keep CircuitMess Sparkly in a ventilated room during the use and assembly. Pay special attention to this if you suffer from a physical condition that affects your ability to detect heat on your body.

Assembling or using CircuitMess Sparkly in an area with a potentially explosive atmosphere, such as areas where the air contains high levels of flammable chemicals, vapors, or particles (such as dust or metal powder), can be dangerous.

Exposure of CircuitMess Sparkly to environments with high concentrations of industrial chemicals, including liquefied gases that evaporate, such as helium, can damage the functionality of CircuitMess Sparkly.

Do not use CircuitMess Sparkly in hospital operating rooms or intensive care units.

Contact your doctor or our customer support (contact@circuitmess.com) to determine if the device's operation may compromise the work of medical devices.

To avoid possible interference with a pacemaker, maintain a minimum distance of 15 cm between the CircuitMess Sparkly and the pacemaker.

To achieve this, do not carry the included device in your pockets.

Do not use CircuitMess Sparkly near hearing aids or similar medical aids and equipment to avoid interference with medical equipment.

Check aircraft safety regulations and turn off CircuitMess Sparkly on the aircraft if necessary.

Do not use CircuitMess Sparkly while driving.

To avoid lightning strikes, do not use CircuitMess Sparkly outdoors during storms.

Do not use the CircuitMess Sparkly in high-humidity environments such as bathrooms. Failure to do so may result in electric shock, injury, fire, and damage to the product, electronic components, power adapter, or other parts of this electronic educational kit.

Follow all the rules that limit the use of portable electronic devices in some situations and conditions.

The individual parts and components in the CircuitMess Sparkly can pose a choking risk to children under 36 months. Keep all components, tools, and parts of this product away from small children before and after assembling the device.

Additional Recommendations and Precautions for Parents, Guardians, and Teachers Buying CircuitMess Sparkly for Children

- 1.** Carefully follow the instructions for adequately assembling CircuitMess Sparkly. Keep these and all other instructions that came with the products in a safe place.
- 2.** Supervise your child while assembling and using the CircuitMess Sparkly. Your responsibility is to ensure that the child uses the CircuitMess Sparkly correctly and that the CircuitMess Sparkly is suitable for the child's age and abilities.
- 3.** Check from time to time if CircuitMess Sparkly is damaged or worn out in any way to prevent possible injuries and risks to the child's health and safety. If CircuitMess Sparkly is damaged, remove it immediately.
- 4.** Remove any unnecessary packaging, but keep the instructions. Take care that children do not play with any plastic packaging as there are suffocation risks.

5. Teach children to always store CircuitMess Sparkly and other parts of the CircuitMess Sparkly educational kit appropriately to prevent accidents. Do not leave CircuitMess Sparkly on stairs or on the floor in your home or classroom where someone can step on it.

6. Always report a product security issue to our customer support (contact@circuitmess.com)

Declaration of Conformity

CircuitMess d.o.o. declares that this DIY educational kit CircuitMess Sparkly model complies with the essential requirements and all other relevant provisions of Directive 2014/53 / EU. The full text of the EU declaration of conformity is available at the following Internet address: circuitmess.com/certification.

Legal Information

This device can be used in all EU Member States. Check all the national and local regulations about using the device. This device may be restricted for use, depending on local laws.

Manufacturer:

CircuitMess d.o.o.

Ventilatorska cesta 24,

10250 Lučko,

Zagreb,

Croatia

OIB: 50943449035

Proper disposal of this product

WEEE markings on the product indicate that this product may not be disposed of with the rest of your household waste in the EU. To prevent possible damage to

the environment or human health from uncontrolled waste disposal, recycle the product responsibly. Recycling promotes the sustainable reuse of resources. For more information on the disposal of electrical and electronic equipment, don't hesitate to contact your local household waste disposal service, the store where you purchased the kit, or our customer support (contact@circuitmess.com).

IMPORTANT! Warranty conditions:

The warranty is valid only if the original invoice is attached to the product as proof of purchase during the complaint. If the customer sends the product for repair for any reason not covered by the warranty, the customer may be charged for inspection and testing and delivery costs.

WARRANTY STATEMENT

CircuitMess d.o.o., with its registered office in Zagreb, Croatia, Ventilatorska cesta 24, guarantees the quality and proper functionality of the components that come in the CircuitMess Sparkly DIY educational kit for a duration of 24 months from the date of purchase.

If the assembled device does not work correctly due to defects in supplied parts or electronic components supplied in the CircuitMess Sparkly DIY educational kit, CircuitMess d.o.o. will repair the product or send an equivalent replacement product at their own expense.

In case you are experiencing assembly or functionality difficulties with your device, please contact us via email (contact@circuitmess.com).

Please include a detailed description of the problem.

If you are sending the product to a repair shop, it is recommended to deliver the product in the original

packaging to protect it from potential damage during transportation.

WARRANTY CONDITIONS

- The warranty period begins on the day of sale indicated on the invoice.
- The warranty is valid upon presentation of the original invoice.
- If the defect is not remedied within a reasonable period after receiving the product for repair, CircuitMess d.o.o. will replace it with a new product.
- The repair shop does not take responsibility for storing and/or losing personal data while repairing the device.

WARRANTY DOES NOT COVER

- Upgrades, alterations, modifications to hardware and/or software without the written consent of CircuitMess d.o.o.
- Malfunctions due to improper handling, faults due to wear of the device and/or its parts (in you need help with assembly or if you have difficulty using the device after assembling it, please contact us at contact@circuitmess.com).
- Defects caused by external particles (including, but not limited to: staples, waste, dust, food) and external factors (including, but not limited to: moisture, water, thermal damage).
- Mechanical damage and/or failures caused by mechanical damage.
- Use of the product for a purpose for which it is not intended.
- Requirements for the appearance, technical functionalities, and/or capabilities of the product outside the manufacturer's specifications and/or standards.

- Damages to personal data, other tangible and/or intangible assets of the buyer and/or third parties, indirect damages, lost profits caused by the use of the product, and/or its failure.

- Repairs in an unauthorized repair shop and/or installation of non–original spare parts.

- Damage caused during transportation caused by improper packaging.

The rights under this warranty are the exclusive and final rights of the customer unless otherwise provided by national law.

CircuitMess d.o.o. as the warranty provider and/or its authorized partners will not be liable for any defect, damage, loss, direct or indirect cost, or connection with the delivered products outside the warranty conditions written here.

This warranty does not affect other rights of the customer belonging to him on other legal grounds.

WARRANTY SHEET

Product name:	CircuitMess do-it-yourself educational set for electronics
Warranty on components and parts contained in this set is:	24 months
Date of purchase:	
Seller and point of sale stamp:	
Invoice number:	

Information on interventions during warranty period is entered by a repair shop technician at an authorized repair shop.

Received on	Issued on	Fault description	Warranty extension

Manufacturer:

CircuitMess d.o.o.
Ventilatorska cesta 24,
10250 Lučko,
Zagreb,
Croatia
Country of origin: Croatia
www.circuitmess.com

Authorized repair shop:

CircuitMess d.o.o.
Ventilatorska cesta 24,
10250 Lučko,
Zagreb,
Croatia
Country of origin: Croatia
www.circuitmess.com

 **CircuitMess**









Scan QR code and find more fun
games and lessons!

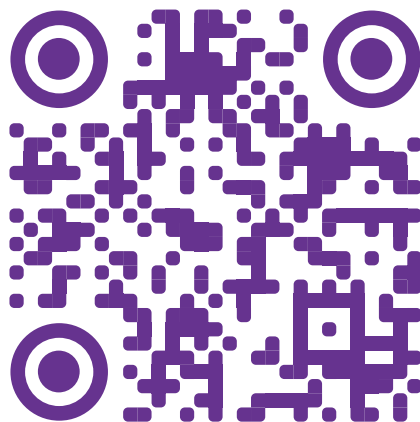

CircuitMess